

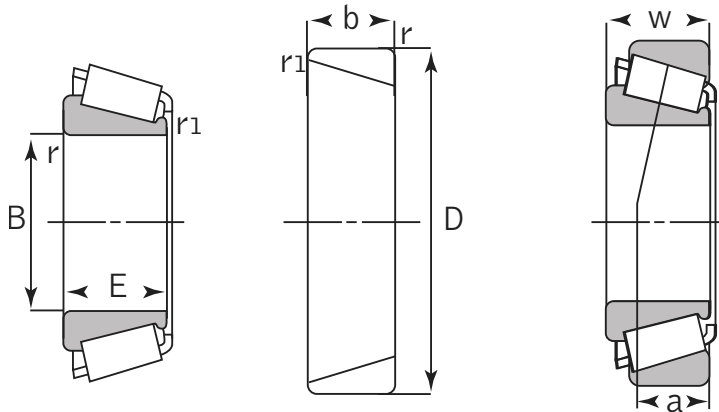

Tapered Roller Bearings

Metric Series



30300

Ass'y No.	Cone Bore (mm)	Cup O.D. (mm)	Bearing W. (mm)	Cone W. (mm)	Cup W. (mm)	Max. Shaft fillet Rad. (mm)	Max. Hang. Fillet Rad. (mm)	Weight (lbs)
	B	D	W	E	b	R	r1	
30304	20	52	16.25	15	13	1.5	1.5	0.33
30305	25	62	18.25	17	15	1.5	1.5	0.51
30306	30	72	20.75	19	16	1.5	1.5	0.73
30307	35	80	22.75	21	18	2	1.5	0.95
30308	40	90	25.25	23	20	2	1.5	1.08
30309	45	100	27.25	25	22	2	1.5	1.21
30310	50	110	29.25	27	23	2	2	1.58
30311	55	120	31.5	29	25	2.5	2	1.96
30312	60	130	33.5	31	26	3	2.5	2.53
30313	65	140	36	33	28	3	2.5	2.77
30314	70	150	38	35	30	3	2.5	2.97
30315	75	160	40	37	31	3	2.5	3.59
30316	80	170	42.5	39	33	3	2.5	4.62

31300

Ass'y No.	Cone Bore (mm)	Cup O.D. (mm)	Bearing W. (mm)	Cone W. (mm)	Cup W. (mm)	Max. Shaft fillet Rad. (mm)	Max. Hang. Fillet Rad. (mm)	Weight (lbs)
	B	D	W	E	b	R	r1	
31307	35	80	22.75	21	15	2	1.5	1.18
31308	40	90	25.25	23	17	2	1.5	1.61
31309	45	100	27.25	25	18	2	1.5	2.25
31310	50	110	29.25	27	19	2.5	2	2.84
31311	55	120	31.5	29	21	2.5	2	3.61
31312	60	130	33.5	31	22	3	2.5	4.47
31313	65	140	36	33	23	3	2.5	5.39
31314	70	150	28	28	25	3	2.5	6.42